

1

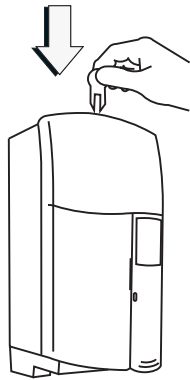

2

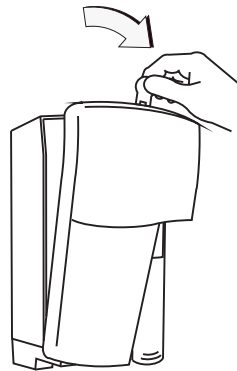

3

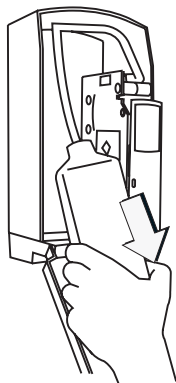

4



5

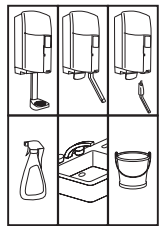
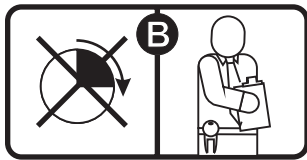
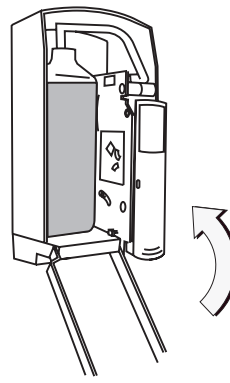

1

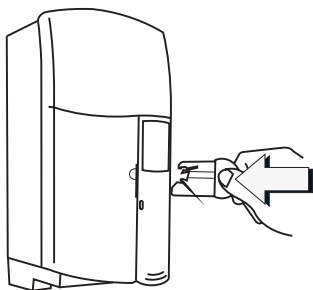

2 a

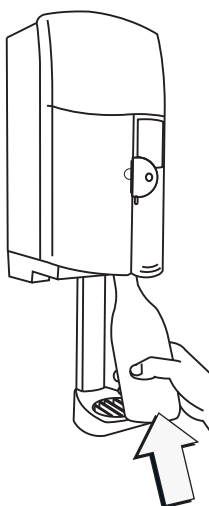

2 b

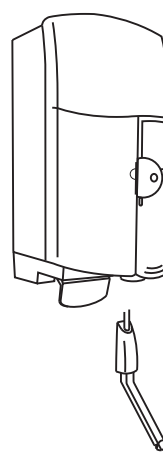

3

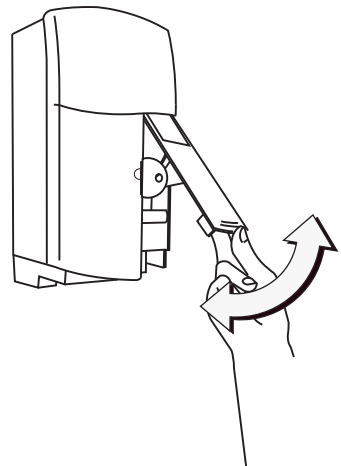

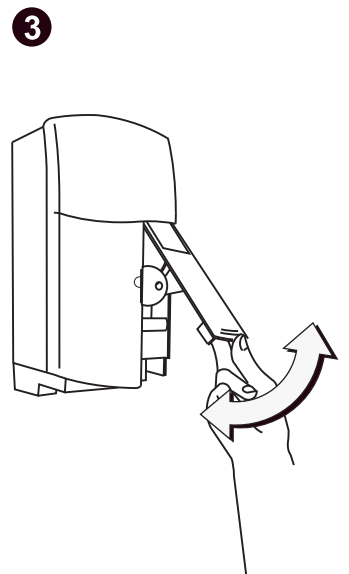
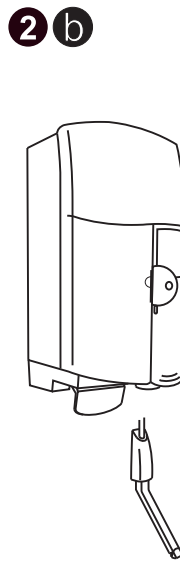
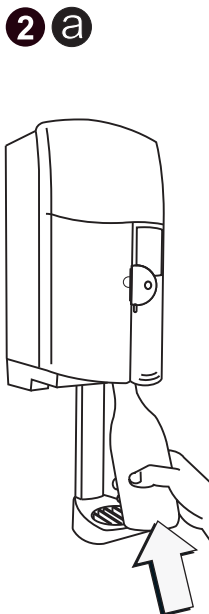
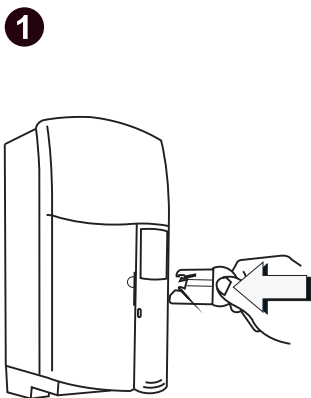
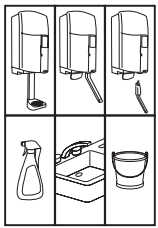
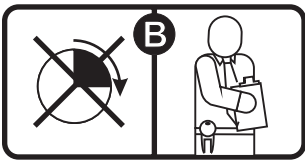
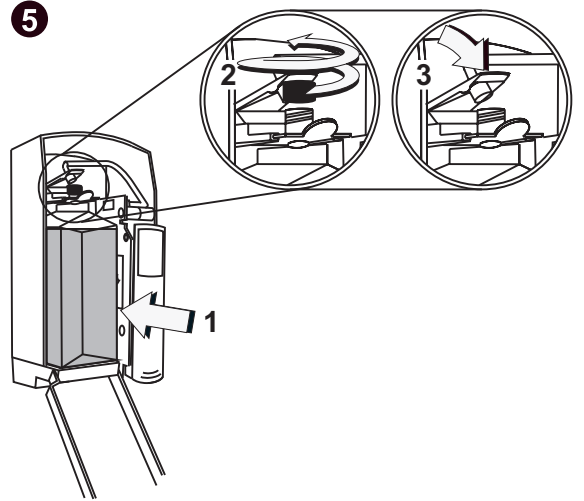
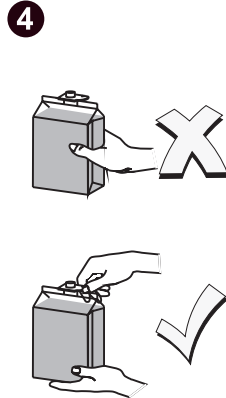
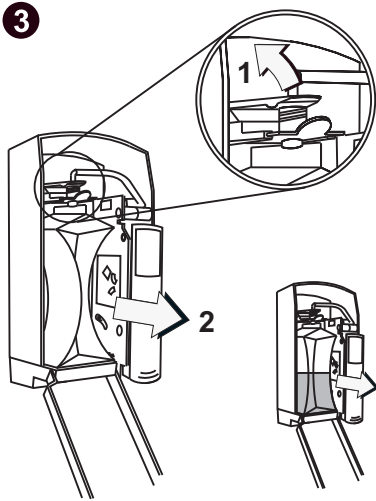
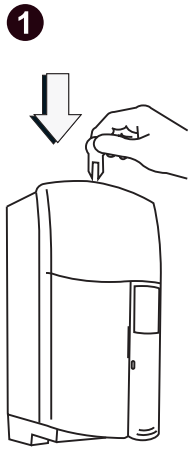
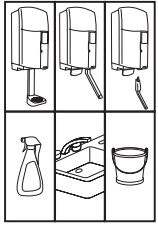
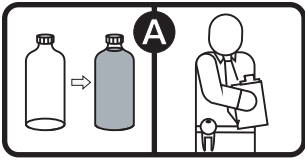

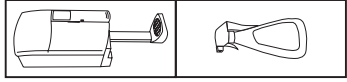
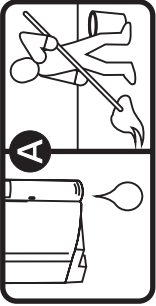

1

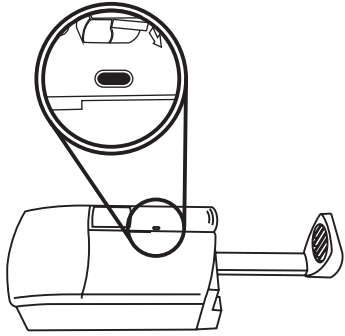

2

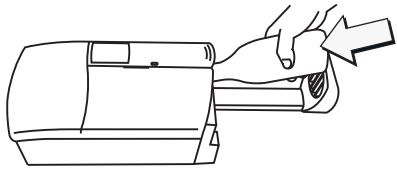

3

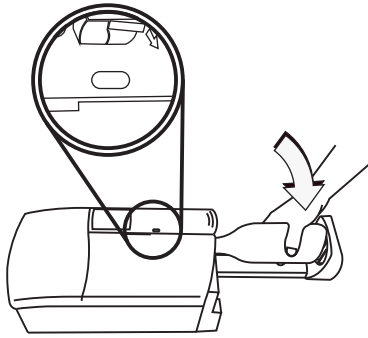

4

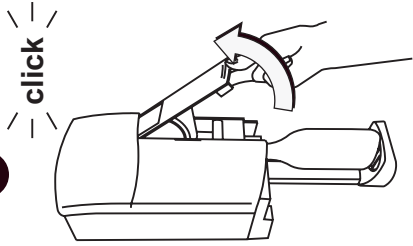

5

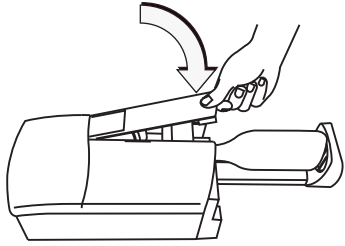

6

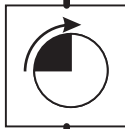
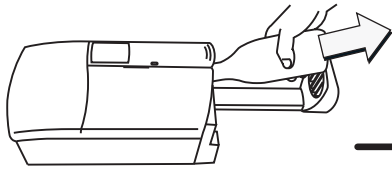

1

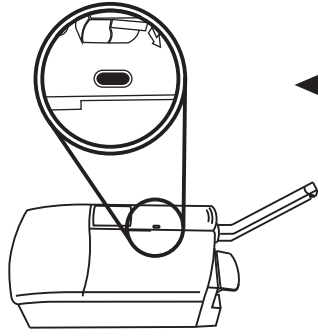

2

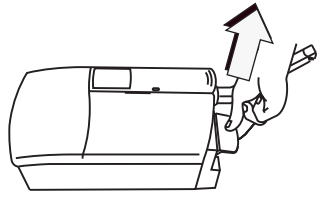

3

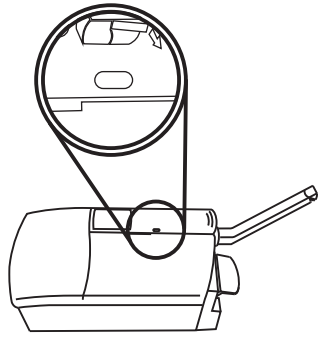

4

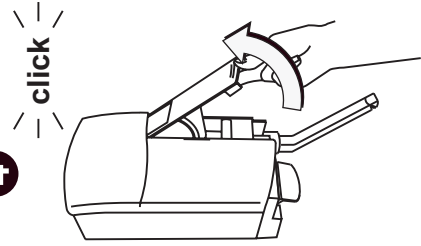

5

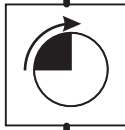
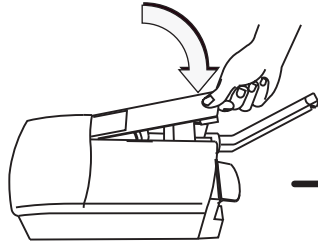

super C

BRIGHTWELL

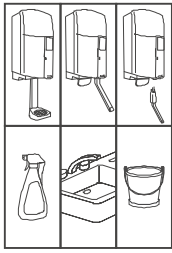
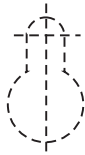
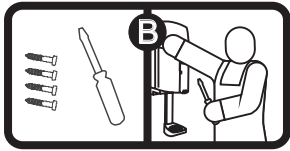

1

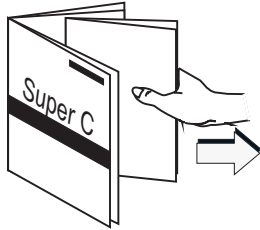

2

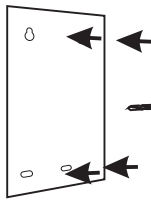

5.5mm

3

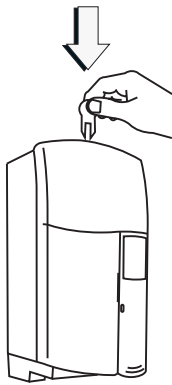

4

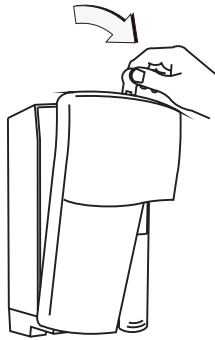

5

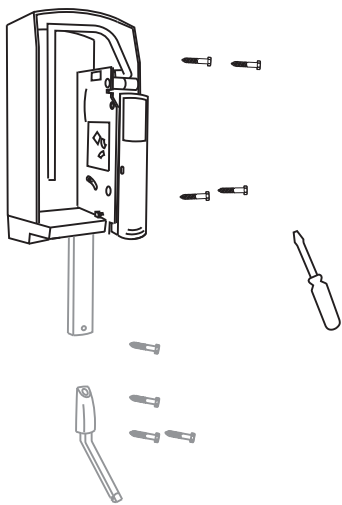

50-150mm

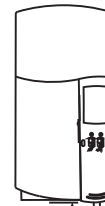
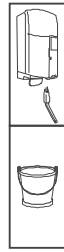

1



2

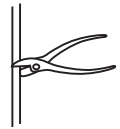

3



Max 1100mm

Max 1100mm

